



Project \_\_\_\_\_  
Item # \_\_\_\_\_  
Quantity \_\_\_\_\_

## 30 Cup Rice Cooker & Warmer with Hinged Lid

Model: RC-S301

Both a cooker and warmer, the Electric Rice Cooker from Winco is designed to keep rice at the ideal serving temperature and texture.

### Standard Features

- ◆ Holds 30 cups of uncooked rice or 60 cups of cooked rice
- ◆ Fingerprint-proof satin finish; heavy-duty stainless steel body
- ◆ Non-stick inner pot seals in moisture
- ◆ Energy-efficient heat absorption system
- ◆ Automatically keeps rice warm for up to 6 hours
- ◆ Includes inner pot, measuring cup and serving paddle
- ◆ One year parts and labor warranty



RC-S301



### Options & Accessories

RC-S301PN	Inner Pot
RCS301-P1	Measuring Cup
RCW-P1	Serving Paddle
RCS301-P8	Fuse
KC-Series	Chinese Cleaver
WOK-Series	Chinese & Japanese Style Woks
SCS-Series	Stainless Steel Skimmers

#### For California Customers

 **WARNING:** Cancer and Reproductive Harm - [www.P65Warnings.ca.gov](http://www.P65Warnings.ca.gov)

 **Headquarters:** 888-946-2682  
**Showroom:** 786-536-4656

 [equipsales@wincous.com](mailto:equipsales@wincous.com)

 [www.wincous.com](http://www.wincous.com)

 • Lodi, New Jersey  
• Miami, Florida  
• Las Vegas, Nevada

# Winco® 30 Cup Rice Cooker & Warmer with Hinged Lid

Model: RC-S301

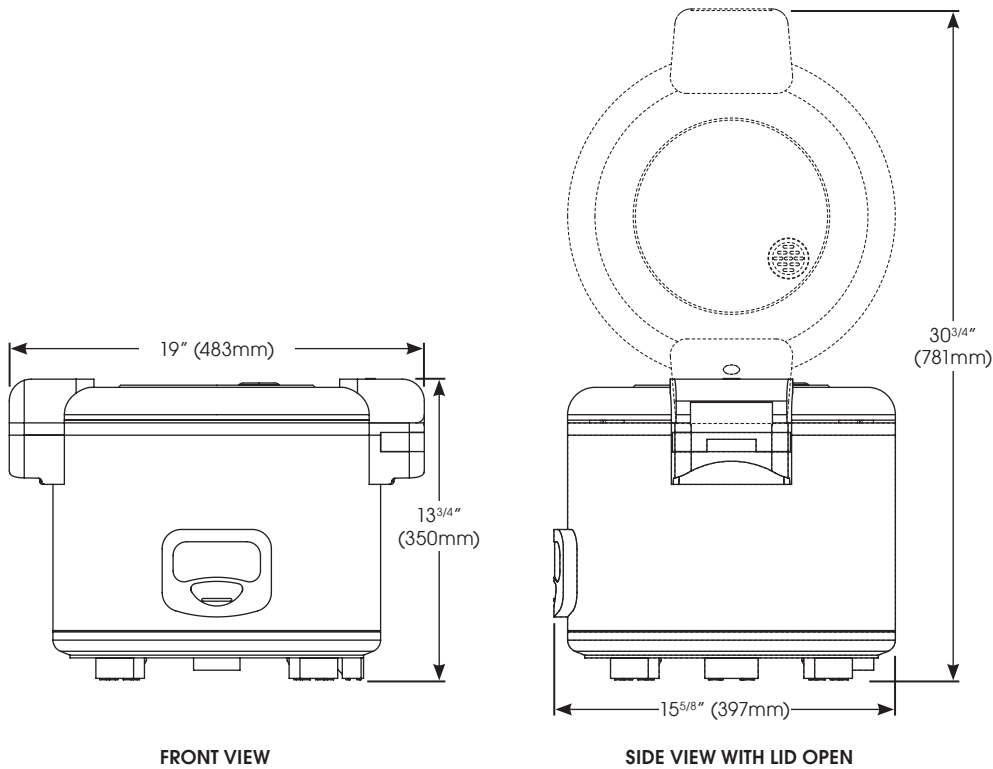

## Specifications

MODEL	DESCRIPTION	OVERALL DIMENSIONS			VOLTS	HZ	WATTS	AMPS	PLUG	SHIP WEIGHT
		LENGTH	DEPTH	HEIGHT						
RC-S301	Rice Cooker/Warmer with Hinged Lid	19" (483mm)	15-5/8" (397mm)	13-3/4" (350mm)	120	60	1550	13	NEMA 5-15P	24 lbs (10.9 kgs)

## Cord Location

Back of unit on the bottom

## Plug Configuration

NEMA 5-15P

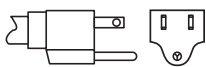

## Product Specs

### 30 Cup Rice Cooker & Warmer with Hinged Lid

The Rice Cooker & Warmer with Hinged Lid model RC-S301 as manufactured by Winco®, Lodi, NJ 07644.

Rice Cooker & Warmer with Hinged Lid shall be rated at 1550 Watts with NEMA 5-15P plug. Units shall be constructed of fingerprint-proof satin finish; heavy-duty stainless steel body and includes a non-stick inner pot, measuring cup, and serving paddle. The non-stick inner pot seals in moisture and holds up to 30 cups of uncooked rice or 60 cups of cooked rice. Rice Cooker & Warmer automatically keeps rice warm for up to 6 hours.

cETLus and ETL Sanitation listed.

Warranty consists of one year parts and labor.

 **Headquarters:** 888-946-2682  
**Showroom:** 786-536-4656

 [equipsales@wincous.com](mailto:equipsales@wincous.com)

 [www.wincous.com](http://www.wincous.com)

 • Lodi, New Jersey  
• Miami, Florida  
• Las Vegas, Nevada