



Project:

Item Number:

Quantity:

10 LB STANDARD-DUTY ELECTRIC FRYERS



CF2-1800



CF2-1800DUAL

DESCRIPTION

Vollrath® Standard Duty Fryers are designed to create a delicious variety of crisp, fried food with minimal fuss. Delight your customers with French fries, chicken, seafood, and more.

CLEARANCE AND ENVIRONMENTAL REQUIREMENTS

- Minimum clearance from combustible construction: 6" (15 cm) from the sides and back of the fryer.
- Minimum clearance from surface flames from adjacent equipment: 16" (40.6 cm).
- Do not install under combustible materials.
- Should be installed under a hood in accordance with the latest edition of the Standard for Ventilation Control and Fire Protection of Commercial Cooking Operations, NFPA 96.
- Locate the fryer in a place where it cannot be pushed off the countertop.
- Keep the area surrounding the fryer clear of combustible materials.
- Keep the area at the front of the fryer clear for unobstructed access during operation.
- Do not place adjacent to a heat-producing appliance.

AGENCY LISTINGS



* Only applies to -C models.

Due to continued product improvement, please consult vollrathfoodservice.com for current product specifications.

WARRANTY

All models shown come with Vollrath's 1-year standard warranty against defects in materials and workmanship. For full warranty details, please refer to vollrathfoodservice.com.

Approvals	Date

ITEMS

Item	Model	Description
CF2-1800	FFA7110	Countertop Fryer, 10 lb.
CF2-1800-C	FFA7110-C	Countertop Fryer, 10 lb. (Canada)
CF2-3600	FFA8110	Countertop Fryer, 10 lb.
CF2-3600-C	FFA8110-C	Countertop Fryer, 10 lb. (Canada)
CF2-1800DUAL	FFA7020	Dual Countertop Fryer, 2 X 10 lb.
CF2-1800DUAL-C	FFA7020-C	Dual Countertop Fryer, 2 X 10 lb. (Canada)
CF2-3600DUAL	FFA8020	Dual Countertop Fryer, 2 X 10 lb.
CF2-3600DUAL-C	FFA8020-C	Dual Countertop Fryer, 2 X 10 lb. (Canada)

Accessories	Description
351796	Small Fryer Basket (two per well included)
351807	Large Fryer Basket
351802	Night Cover (one per well)

FEATURES & BENEFITS

- Vollrath 208-240V standard duty fryer heads now come with 20% more power
- New components improve quality, durability, and safety
- Non-skid rubber feet prevent slipping
- Each box is wired separately with a 4 ft. (1.3m) cord and plug
- Indicator light illuminates when oil is ready
- Magnetic switch cuts power when element box is removed
- Minimal footprint to accommodate tight counter spaces
- Three-position fryer head for easy cleaning and pan removal
- Thermostatically controlled to 375 °F (190 °C)
- Automatic thermal overload shutoff at 500 °F (260 °C)
- Lighted Power Switch indicates power is on
- Stainless steel wire baskets with cool-touch handle
- Removable element box assemblies for easy cleaning and versatility
- Ideal for small pubs, colleges, and product-specific applications
- Dual unit provides increased volume and separation of food types to prevent flavor transfer
- Lift-out, one-piece stainless steel tank with carrying handles for easier cleaning
- Quick heat-up and temperature recovery between loads
- Ships with two baskets per well



DIMENSIONS

Shown in inches (cm)

Single Fryer

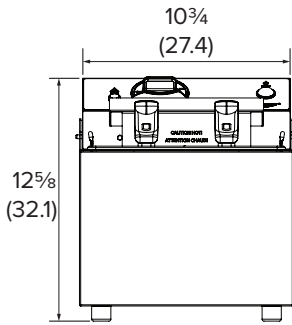

Front View

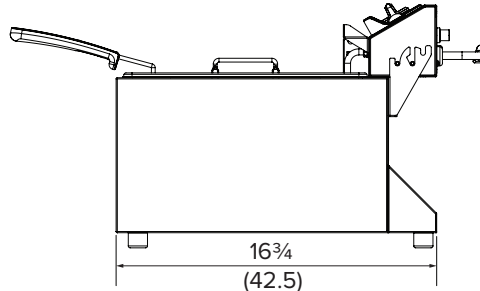

Side View

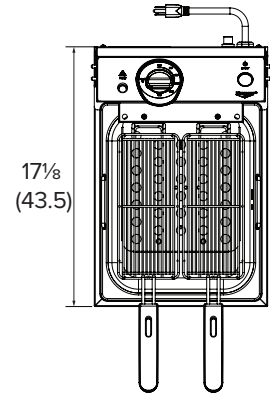

Top View

Dual Fryer

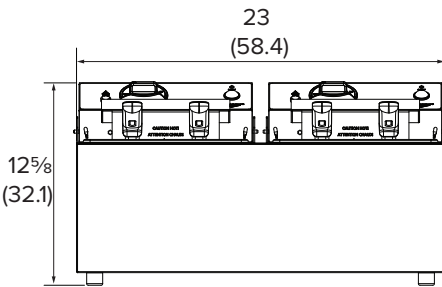

Front View

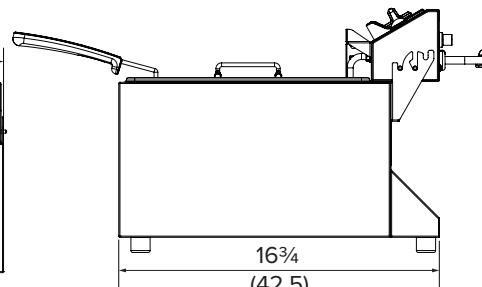

Side View

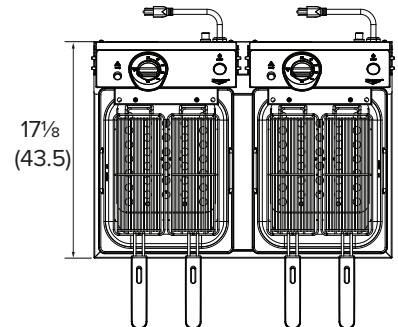

Top View

SPECIFICATIONS

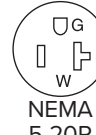
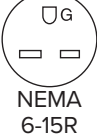
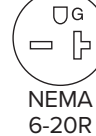
Item	Description	Voltage	Watts	Amps	Shipping Weight LB (KG)	Plug	Receptacles	
							120V	120V
CF2-1800	Single Fryer	120	1800	15	21 (9.5)	NEMA 5-15P	 NEMA 5-15R	 NEMA 5-20R
CF2-1800-C						NEMA 5-20P		
CF2-3600		208-240	2700-3600	13-15		NEMA 6-15P		
CF2-3600-C						NEMA 6-20P		
CF2-1800DUAL	Dual Fryer	120	1800 per well	15 per well	40 (18.1)	NEMA 5-15P*	 NEMA 5-15R	 NEMA 5-20R
CF2-1800DUAL-C						NEMA 5-20P*		
CF2-3600DUAL		208-240	2700-3600 per well	13-15 per well		NEMA 6-15P*		
CF2-3600DUAL-C						NEMA 6-20P*		

* Each fryer head requires a dedicated circuit and the electrical ratings are per circuit.



The Vollrath Company, L.L.C.

1236 North 18th Street
Sheboygan, WI 53081-3201 U.S.A.
Main Tel: 800.624.2051 or 920.457.4851
Main Fax: 800.752.5620 or 920.459.6573
Customer Service: 800.628.0830
Canada Customer Service: 800.695.8560

© 2022 The Vollrath Company L.L.C.

Technical Services

techservicereps@vollrathco.com
Induction Products: 800.825.6036
Countertop Warming Products: 800.354.1970
All Other Products: 800.628.0832

Form L36207

12/16/22